

# Instruction Manual

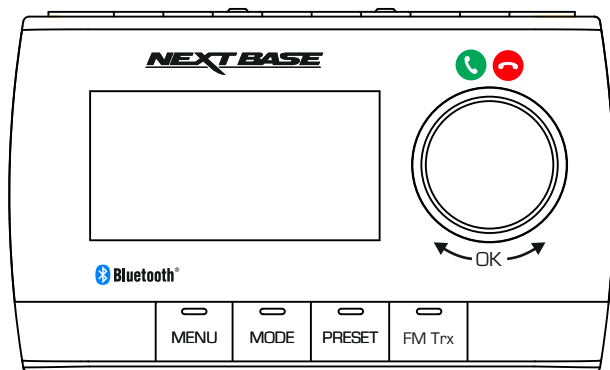

**ADAPT**  
**DAB350BT**

**DIGITAL DAB RADIO ADAPTER**

Digital DAB/DAB+ radio with Aux in, Bluetooth, Line out and FM transmitter



## INTRODUCTION TO USING A DIGITAL RADIO ADAPTER

The Adapt range of Digital radios have been designed specifically with ease of use in mind, it is recommended NOT to change the default settings, which have been carefully selected to give the best performance for day to day use.

### Basic operation.

The Adapt DAB radio will automatically perform a full scan when first turned on, so the supplied Antenna must be correctly installed and connected to the DAB Adapter before connecting the Car Power Cable. Follow the in-vehicle installation instructions on page 12 for information on how to correctly install your DAB adapter.

**Automatic Start / Stop Technology.** The DAB adapter senses power supplied to the cigarette lighter socket as soon as the vehicle ignition is turned on and will start the radio automatically. When the ignition is turned off, the DAB adapter will perform an automatic shutdown process after a set time which can be adjusted in the menu.

### Note:

If the vehicle in which the DAB adapter is installed has permanent live cigarette lighter sockets, the user can simply use the power button on the bottom of the unit to switch the adapter off.

To take advantage of the Automatic Start / Stop Technology a Nextbase Hardwire Kit can be installed on a switch-live power supply.

### 1. Tips for using the DAB adapter:

- 1.1 Make sure that the Antenna is correctly installed. Follow the instructions on page 12 to ensure that the DAB adapter receives the best signal.
  
- 1.2 If using the DAB adapter in a vehicle with stop/start technology in which the cigarette lighter socket does not supply power when the engine stops, change the auto power off time to 5 minutes so that in when the cigarette lighter socket stops supplying power, your DAB radio adapter remains on.
  
- 1.3 If a radio station is not present within the stations list, try performing a full scan.

**TABLE OF CONTENTS**

INTRODUCTION TO USING A DABADAPTER -----	03
TABLE OF CONTENTS -----	04
PRECAUTIONS -----	05
CAUTIONS ON USING THIS PRODUCT -----	05
PRODUCT SPECIFICATION -----	06
PACKAGE CONTENTS -----	07
PRODUCT FEATURES -----	07
WINDSCREEN MOUNT -----	08
PARTS AND CONTROLS -----	09
IN VEHICLE INSTALLATION -----	12
CONNECTING TO DAB ADAPTER VIA BLUETOOTH -----	17
HANDSFREE CONFIGURATION -----	18
RECEIVING CALLS -----	19
DAB MODE -----	20
DAB MENU -----	21
AUX IN MODE -----	23
AUX IN MENU -----	24
BLUETOOTH MODE -----	25
BLUETOOTH MENU -----	26
TROUBLE SHOOTING -----	27
NOTES -----	29

## PRECAUTIONS

Please read this manual carefully before operation and keep it for future reference. It will be helpful should you encounter any operational problem.

**WARNING:** Do not expose this product to rain, moisture or water under any circumstances, doing so may result in the risk of electric shock or fire.

**CAUTION:** To reduce the risk of electric shock, do not perform any servicing other than that contained in the instruction manual unless you are qualified to do so.

Have the unit serviced by a qualified service technician if:

The unit has been exposed to rain or water.

The unit does not seem to operate normally.

The unit exhibits a marked change in performance.

**LCD:** A Liquid Crystal Display (LCD) screen is a multilayer complex component, containing 8,192 pixels. Pixels can however fail during normal product life. 1 pixel = 0.01% failure rate, and one pixel failure per year of operation is considered normal and not a cause for concern.

**WEEE:** Disposal of Waste Electrical and Electronic Equipment and/or Battery by users in private households in the European Union.



This symbol on the product or on the packaging indicates that this cannot be disposed of as household waste. You must dispose of your waste equipment and/or battery by handing it over to the applicable take-back scheme for the recycling of electronic equipment and/or batteries. For more information please contact your local household waste disposal office.

## CAUTIONS ON USING THIS PRODUCT

1. Ensure that the mounting location is free of dirt or grease before placing mount upon it.
2. Do not obscure the view of the road ahead or impede the deployment of any airbags in the event of an accident.
3. When not in use, please disconnect the car adaptor from both the 12/24Vdc outlet in your vehicle and the device itself.
4. Only clean the device with a soft dry cloth, for tough dirt, apply some neutral detergent diluted in 5 to 6 parts water to a soft cloth.

**Note :** alcohol, thinner, benzene etc. could cause damage to the paint or coatings.







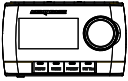

5. Whilst driving, do not adjust the controls of your device as this is a distraction to driving.

**PRODUCT SPECIFICATION**

Model Number	NBDAB350BT
Power Requirements	5V / .5A
Power Supply	12-24Vdc Car Power Cable (supplied) Fuse Type: 20mm / 2A Output: 5Vdc
DAB Frequency Range	174-240MHz
FM Transmitter Frequency Range	87.5-108MHz
Bluetooth Frequency Range	2402-2480MHz
Screen Size	2.4"
Screen Resolution	128 (W) X 64 (H) pixels
Screen Ratio	2:1
Internal Battery	Lithium-ion 3.7V / 230mAh (approx. 30mins radio listening) Battery design allows the 'Auto Power Off' feature to function in event of power loss within the vehicle. It is not intended as an alternative power source to replace the supplied car adaptor.
Unit Dimensions	102 x 60 x 31.5mm
Unit Weight	100.5g

## PACKAGE CONTENTS

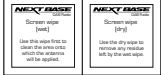
Please check the contents of your NEXTBASE product.

<p><b>DAB Radio Adapter</b></p> 	<p><b>Windscreen Mount</b></p> 	<p><b>Adhesive Mount</b></p> 	<p><b>Car Power Cable</b></p> 
<p><b>Antenna</b></p> 	<p><b>Cable Clips</b></p> 	<p><b>Cable Ties</b></p> 	<p><b>Screen Wipes</b></p> 
<p><b>Installation Guide</b></p> 			

Product appearance may differ slightly to that shown above.

## PRODUCT FEATURES

Thank you for purchasing this NEXTBASE Digital DAB radio adapter, this section will outline some of the features of this Digital DAB radio.

Digital DAB/DAB+ radio with automatic service following function for seamless listening  
Service following function allows one to travel between different broadcasting masts and chooses the strongest signal for the chosen station.

### Line out

The line out audio output delivers superior sound quality, allowing DAB/DAB+ radio quality to be fully appreciated.

### FM transmitter

For vehicles without Aux-in connections, and for users who want wire free audio transmission, The FM transmitter searches for the channel with least interference, allowing easy transmission with the best audio quality.

### Built in battery

Battery allows for seamless use with stop/start vehicles and for use without vehicle engine running.

### Aux-in

Aux-in allows music playing devices to be connected, and listened to through your car speaker system.

### Bluetooth Hands free and music streaming

Bluetooth connectivity for hands free phone calling, and music streaming.

## WINDSCREEN MOUNT

Please see below to identify the parts of the supplied windscreen mount.

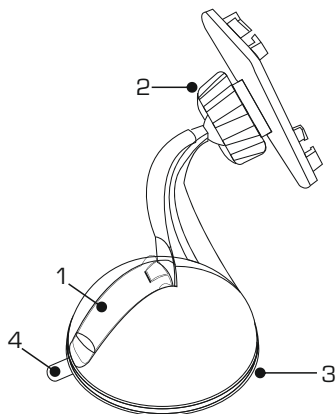

- 1. Locking lever**  
The locking lever is used to attach and release the window mount to your vehicles windscreen. Pull the lever down to prepare the window mount for use. Once the mount is firmly upon the windscreen (in a suitable location) push the lever to lock the mount in place.
- 2. Locking ring**  
Loosen the locking ring to adjust the DAB adapter position if required, remembering to re-tighten before use.
- 3. Suction cup**  
This is used to attach and release the windscreen mount to your vehicles windscreen.  
  
Only attach to an area of the windscreen where there is no paint effect applied.
- 4. Suction release tab**  
Once the locking lever has been opened use this release tab to break the seal between the mount and windscreen.



**DIGITAL RADIO ADAPTER - PARTS & CONTROLS**

Please see below to identify the parts and controls of your Digital Radio Adapter.

Rear:

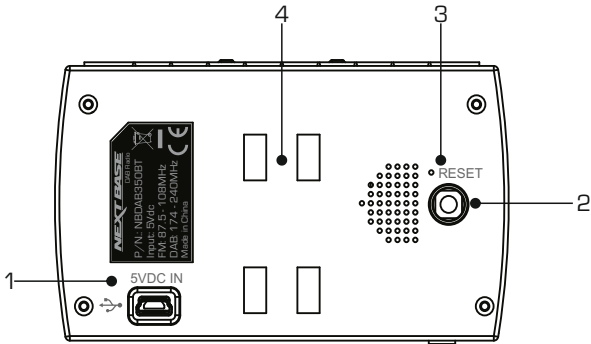

1. 5VDC in and USB connection  
Connect the supplied car power cable here.
2. Threaded Antenna Connection  
Connect the antenna here by carefully screwing it on, only tighten by hand. Tighten until the coaxial cable no longer freely rotates.
3. Reset button  
In the unlikely event that your DAB radio adapter becomes unresponsive, use a paper clip or similar to restart it.
4. Mounting lugs  
Attach the supplied windscreen mount here.

**DIGITAL RADIO ADAPTER - PARTS & CONTROLS (CONTD.)**

Front:

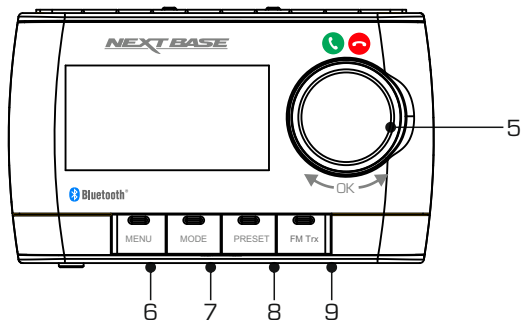

5. **Scroll Wheel/OK Button**  
The scroll wheel is used to choose radio stations and navigate the menu system. The scroll wheel also functions as an OK button when pressed. This is used to confirm a selection or action.  
  
Short press: OK/picks up incoming calls.  
  
Long press: Opens hands free menu/rejects incoming calls.
  
6. **Menu Button**  
Short press: Short pressing the menu button cycles through information about the selected radio station.  
  
Long press: Opens the menu.
  
7. **Mode Button**  
Press to change between DAB and Aux-in modes.
  
8. **Preset Button**  
Short press: Short pressing the preset button opens the preset menu.  
  
Long press: Allows the current station to be stored as a preset.
  
9. **FM Trx [Transmitter] Button**  
Short press: Short pressing the FM Trx button allows the FM transmission frequency to be set manually, using the scroll wheel.  
  
Long press: Automatically searches and chooses the FM frequency with the least interference, and sets the DAB radio adapter to transmit at this frequency.

**DIGITAL RADIO ADAPTER - PARTS & CONTROLS (CONTD.)**

Top:

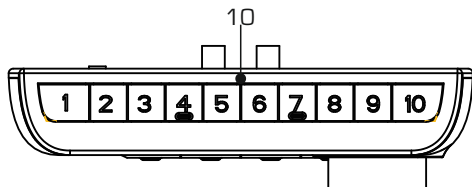

10. Preset Buttons

Short press: Select a previously stored preset station.

Long press: Store the current radio station as a preset.

Preset button 10: Whilst in Bluetooth mode and connected to a mobile device, short pressing button 10 manually synchronises the devices contacts.

Bottom:

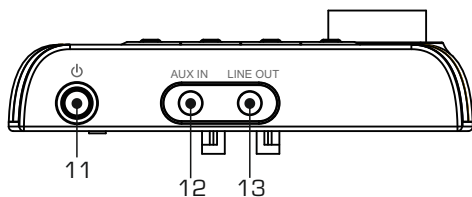

11. Power button

Long press: Power unit on/power unit off.

12. Aux In 3.5mm jack

Used to connect an audio device.

13. Line Out 3.5mm jack

Used to connect the DAB adapter to compatible vehicles line in connections.

## IN VEHICLE INSTALLATION

Please read and follow the notes below regarding the positioning of the DAB digital radio adapter within the vehicle. The DAB adapter is supplied with both a windscreen mount and adhesive mount for flexibility of installation.

When positioning the DAB radio adapter you must adhere to the following points;

- 1) The DAB adapter must not obstruct the drivers view.
- 2) The DAB adapter must not be positioned so that it interferes with or is in the path of airbag deployment.
- 3) The DAB adapter must not obstruct your view of any of the controls or instruments in the vehicle.
- 4) The DAB adapter must not obstruct the view of the wing or rear view mirrors.

The DAB adapter should be installed so as not to intrude significantly within the wiped area. A 40mm intrusion into the green wiped area is the maximum permitted by law.

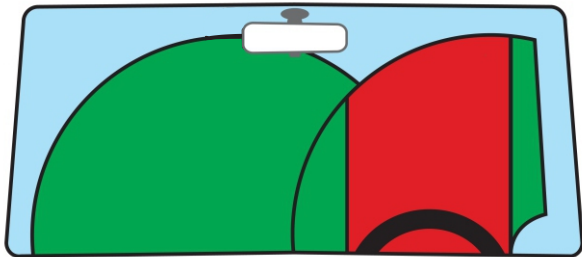

Do NOT mount the DAB adapter in front of the driver, as depicted by the red area in the above illustration.

When installing the DAB adapter in a vehicle, always make sure that it is mounted securely. If possible the cables running to the device should be concealed under the cars trim. Make sure that none of the cables interfere with the drivers operating controls, such as the steering wheel, pedals or gear lever. The cables also should not obstruct ones view of any of the vehicles instruments.

Clean the windscreen at the point of location, prior to fitting the DAB adapter. Applying some moisture to the suction cup may be beneficial, to ensure absolute adhesion.

**IN VEHICLE INSTALLATION (CONTD.)**

Please follow the instructions below for first-time installation of the Digital DAB Radio.

**1. Installing the Active Antenna**

Correct installation of the active antenna is crucial for good DAB radio reception. The antenna should not obstruct the drivers view. It should be installed on the passenger side of the vehicle, as shown below.

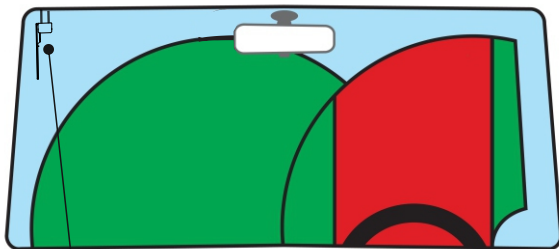

Antenna positioning for right hand drive vehicle.

Once a suitable location has been found for the Antenna, the first step is to install the magnetic ground.

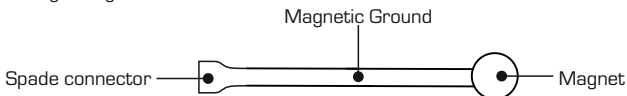

The Magnetic ground must be affixed to a ferrous object, i.e. the vehicles body. Typically this is achieved by sliding the magnetic ground under the roof lining of the vehicle. In most cases you will hear an audible click when the magnet has located itself.

If you lightly pull you will be able to feel that the magnet is securely attached. Once the magnetic ground is located, connect the spade connector to the antenna.

Using the supplied screen wipes, clean the area of the windscreen which the Antenna will be adhered to, thus making sure the windscreen is clean and free of dirt and/or grease.

Remove the adhesive backing from the Antenna film and affix it 2.5cm from the A-pillar, as shown below.

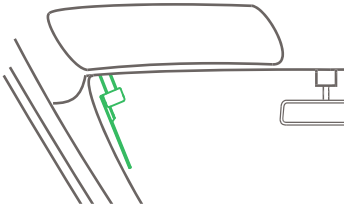

**IN VEHICLE INSTALLATION (CONTD.)**

## 2. Choose location to mount DAB adapter

The DAB adapter is supplied with both a windscreen mount and an adhesive mount so you have the freedom to mount the adapter in the location that suits your vehicle.

If you choose to mount the adapter on your windscreen then position it as low as possible so that it does not obscure your view of the road.

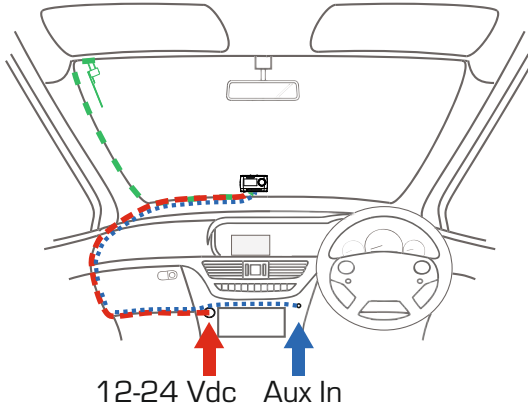

If you choose to mount the DAB radio adapter on the centre console position the DAB radio adapter on an area which does not obscure any controls or instruments.

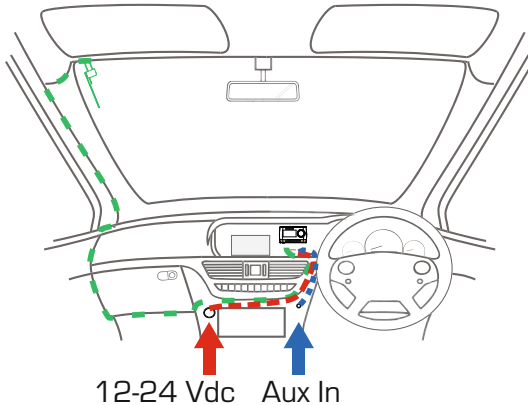

**IN VEHICLE INSTALLATION (CONTD.)****3. Route the cabling to the DAB adapter**

Route the antenna & power cables to the DAB adapter, the cables can then be hidden behind the vehicle's plastic trim, or secured using the supplied adhesive cable clips. Connect the Antenna to the DAB adapter. The Antenna is connected via a threaded connector, this should only be tightened by hand.

Note: do not bend, crease or cut the delicate antenna components. Any excess cable can either be gently tucked behind trim, or coiled up and secured using one of the supplied cable ties.

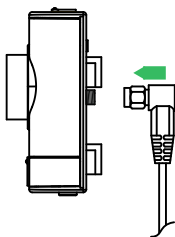

Route the supplied car power cable to the DAB adapter and plug in the mini-usb connector. Plug in the car power cable into the cigarette lighter socket. The DAB adapter will now power on and will start an automatic scan of all the available DAB radio stations.

**4. Connecting the digital DAB radio to your car audio system**

If the vehicle has an Aux in connection then it is recommended to use supplied Line Out cable for the best audio quality. Before connecting the supplied line out cable turn your car audio system to aux-in mode, and turn the volume of your car audio system to zero. Once you have done this you can connect the line out cable to the DAB adapter and route it to the aux in port on your vehicle, slowly turn the volume up on the vehicle.

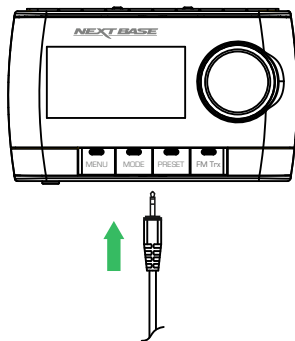

**IN VEHICLE INSTALLATION (CONTD.)**

## 4. Connecting the digital DAB radio to your car audio system (contd.)

If you do not have an Aux in connection in your car or would prefer to have a wire free connection then you can connect your DAB radio adapter & your existing car radio via FM transmission.

With the DAB adapter on the home screen long press the FM Trx button to begin an automatic search of the FM frequencies, during which the following screen will appear.

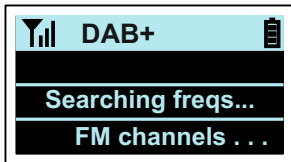

The DAB adapter is conducting a search of FM frequencies from 87.5-108Mhz to find a channel with a suitably low level of interference from any existing radio broadcasts within your area. Once the search has been completed the selected frequency will be shown.

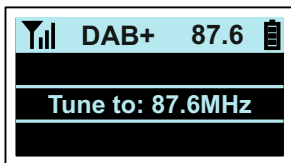

Now tune the vehicle FM radio in which the DAB adapter is being installed to the frequency displayed on the DAB adapter. Refer to the vehicle user manual if necessary.



## CONNECTING TO DAB ADAPTER VIA BLUETOOTH

This section describes how to connect a mobile phone via Bluetooth to the DAB adapter.

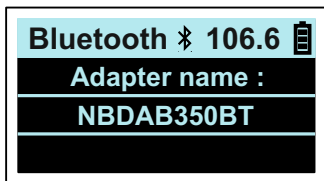

To connect to the DAB Adapter, enter the Bluetooth connections menu in the mobile device and select the "Adapter name" which is displayed on the DAB adapter when it is in Bluetooth mode. If prompted during the pairing process, approve the "Contacts Sharing" option whilst connecting with the mobile device. If you are not prompted to share the devices mobile contacts, then select this option afterwards through the Bluetooth settings menu.

## HANDSFREE CONFIGURATION

Now the mobile device is connected via Bluetooth, Hands free calling can be configured. To make calls from the adapter the mobile device's contacts must be synchronised. To access the mobile devices contacts, long push the scroll wheel. The below screen will appear:

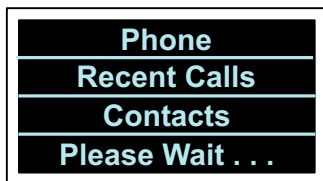

Note: The first time you try to make a call, the mobile device contacts synchronise. Please wait until this is complete, it can take up to 5 minutes if the mobile device has a large number of contacts.

When this message leaves the screen, the contacts from the mobile device have been imported, now if you long press the centre scroll wheel in any mode, you can access your contacts, and make calls via the DAB adapter. The contacts are split alphabetically for quicker navigation. If the mobile device's contacts are not synchronised successfully check that the contacts sharing option is approved within the Bluetooth connection settings on the mobile device.

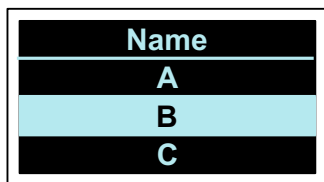

Once the desired contact has been reached in the menu, make the call by pressing the scroll button. To hang up simply press the scroll button again.

Note: Each time a different device is connected via Bluetooth and the contacts menu is accessed the new mobile devices contacts are synchronised.

Note: If new contacts are added to the mobile device, the contact list must be re-synchronised. To manually synchronise the mobile device's contacts, when the DAB adapter is in Bluetooth mode, press the 10<sup>th</sup> preset button.

## RECEIVING CALLS

Now the mobile device is connected via Bluetooth, and hands free calling has been configured. If the mobile device is connected and receives a call, it can be answered with the DAB adapter by clicking the scroll wheel, to reject the call, long press the scroll wheel. The incoming call screen is shown below:

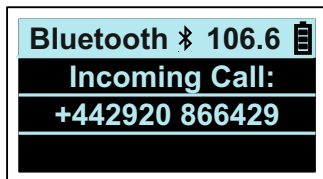

## DAB MODE

The key below explains the various information displayed on the screen when your Digital DAB radio adapter is in DAB mode.

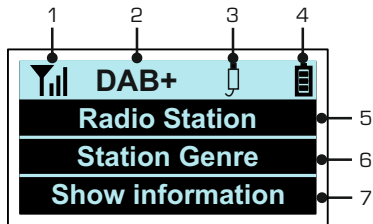

1. Signal strength: indicates the strength of the signal received by the DAB adapter.
2. DAB/DAB+ indicator: indicates whether the station is a DAB or DAB+ broadcast.
3. Audio out indicator: indicates if the Digital DAB audio adapter is broadcasting FM or using the Line out connection.
4. Battery indicator: indicates if battery is being charged, otherwise indicates battery level.
5. Radio station: Displays the name of the radio station selected.
6. Station Genre: Displays the genre being listened to.
7. Show information: displays information about the show being listened to.

## DAB MENU

To access the DAB menu, simply long press the menu button whilst in DAB mode.

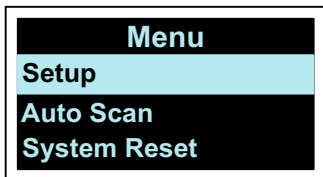

1. System  
Make settings changes to the digital DAB adapter system.
  - a. Brightness  
Select the brightness of the screen.  
Options : High, Medium, Low
  - b. Traffic Information  
Select whether you would like traffic information to interrupt the radio station you are listening to.\*  
Options : On, Off  
  
\*Only available in areas which broadcast traffic information.
  - c. Auto Power Off  
Select the length of time the DAB digital radio adapter remains on before automatically shutting down after the unit stops receiving power.  
Options : 10s, 5m, 20m, 15m
  - d. Line Out Volume  
Select the audio output level for the line out socket.  
  
Note: the Low setting is to be used if distortion is heard on the vehicle speaker system.  
Options : High, Low
  - e. Button Lights  
Select whether you would like the back-light for the buttons to be turned on or off.  
Options : On, Off
  - f. Language  
Select the language for the device menus.  
Options : English, Norwegian
2. Auto Scan  
Perform a full scan for available DAB/DAB+ stations.

**DAB MENU (CONTD.)**

Continued from previous page.

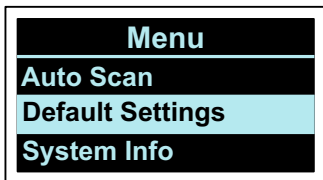

3. **Default Settings**  
Selecting this menu item resets the DAB adapter to its original factory settings.  
Options : On, Off
  
4. **System Info**  
Selecting this menu item opens a page displaying which version of firmware the Digital DAB radio adapter is using.

## AUX IN MODE

The key below explains the various information displayed on the screen when your Digital DAB radio adapter is in 'Aux in' mode.

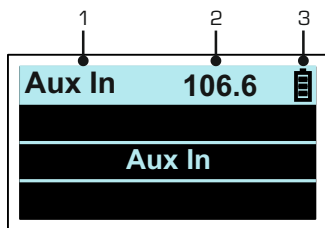

1. Mode title: indicates that you are in Aux In in mode.
2. Audio out indicator: indicates if the Digital DAB audio adapter is broadcasting FM or using line out connection.
3. Battery indicator: indicates if battery is being charged, otherwise indicates battery level.

## AUX IN MENU

To access the Auxiliary menu, simply long press the menu button whilst in Auxiliary mode.

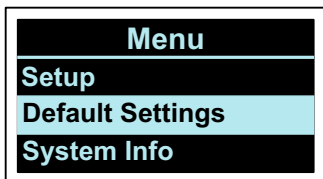

1. Setup  
Make settings changes to the digital DAB adapter system
  - a. Brightness  
Select the brightness of the screen.  
Options : High, Medium, Low
  - b. Auto Power Off  
Select the length of time the DAB digital radio adapter remains on before automatically shutting down after the unit stops receiving power.  
Options : 10s, 5m, 20m, 15m
  - c. Line Out Volume  
Select the audio output level for the line out socket.  
  
Note: the Low setting is to be used if distortion is heard on the vehicle speaker system.  
Options : High, Low
  - d. Button Lights  
Select whether you would like the back-light for the buttons to be turned on or off.  
Options : On, Off
  - e. Language  
Select the language for the device menus.  
Options : English, Norwegian
2. Default Settings  
Selecting this menu item resets the DAB adapter to its original factory settings.  
Options : On, Off
3. System Info  
Selecting this menu item opens a page displaying which version of firmware the Digital DAB radio adapter is using.



## BLUETOOTH MODE

The key below explains the various information displayed on the screen when your Digital DAB radio adapter is in Bluetooth mode.

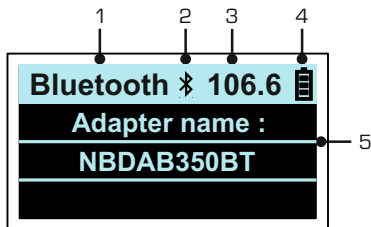

1. Mode title: Labels which mode the DAB adapter is currently in.
2. Bluetooth connection indicator: indicates that a device is connected via Bluetooth.
3. Audio out indicator: indicates if the Digital DAB audio adapter is broadcasting FM or using line out connection.
4. Battery indicator: indicates if battery is being charged, otherwise indicates battery level.
5. Adapter name : States the Bluetooth name of the DAB adapter.

## BLUETOOTH MENU

To access the Bluetooth menu, simply long press the menu button whilst in Bluetooth mode.

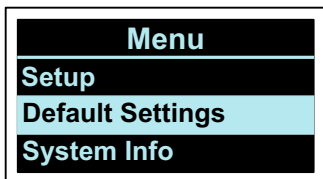

1. Setup
  - Make settings changes to the digital DAB adapter system
  - a. Brightness
    - Select the brightness of the screen.
    - Options : High, Medium, Low
  - b. Auto Power Off
    - Select the length of time the DAB digital radio adapter remains on before automatically shutting down after the unit stops receiving power.
    - Options : 10s, 5m, 20m, 15m
  - c. Line Out Volume
    - Select the audio output level for the line out socket.
  
    - Note: the Low setting is to be used if distortion is heard on the vehicle speaker system.
    - Options : High, Low
  - d. Button Lights
    - Select whether you would like the back-light for the buttons to be turned on or off.
    - Options : On, Off
  - e. Language
    - Select the language for the device menus.
    - Options : English, Norwegian
2. Default Settings
  - Selecting this menu item resets the DAB adapter to its original factory settings.
  - Options : On, Off
3. System Info
  - Selecting this menu item opens a page displaying which version of firmware the Digital DAB radio adapter is using.

## TROUBLE SHOOTING

PROBLEM	SOLUTION
The sucker will not stay in place upon my windscreen.	Ensure that the protective cover (plastic film) has been removed from the suction pad. Moisten the sucker slightly before affixing upon the windscreen. Ensure that the locking lever is fully open when the sucker is pushed on to the windscreen and then close the lever. Make sure that the glass is smooth and clean. Do not stick the windscreen mount to glass that has any non-smooth effect or paint whatsoever. Affix to the glass firmly and then close the locking lever fully.
No power to my adapter, but it works when used with other power sources.	The cigarette power cable is not working. Inspect the fuse in the Car Power plug. Replacement fuse = 2A 20mm type. If the fuse is found to be blown, inspect the power cable for damage which may have caused the fuse blow.
My adapter shuts down by itself after a while.	There is no power to the DAB adapter and the Auto Power Off command has been triggered.
The battery will not charge.	Ensure the DAB adapter is connected to a reliable power source and that the supplied Car Power Cable is being used, with the Car Power Cable LED lit.
The battery does not last for the full auto power off time that is set in the menu.	The battery will only charge when the DAB Digital Radio Adapter is connected to power. Charging takes approximately 90 minutes, so if the DAB digital radio is frequently used when the car engine is not running it will discharge the battery, and if only short journeys are taken the battery will not fully recharge. Charge the battery fully using the supplied Car Power Cable.
The DAB reception is poor.	Check that the Antenna is installed correctly, specifically that the magnetic ground is still attached to the car body, and the coaxial connector on the rear of the radio is securely connected, so that it does not freely rotate. Also check for damage to the coaxial cable.
When using the 'Line Out' function to connect to my car there is distortion of the sound in my vehicle.	Go into the system menu and change the 'Line Out Level' setting to low.
When using the FM transmitter the sound quality is poor.	There is interference on that specific FM frequency, refer to page 16 to change the transmission frequency to one without interference.

**TROUBLE SHOOTING (CONTD.)**

PROBLEM	SOLUTION
The radio is frozen and does not respond.	Use a paper clip or similar thin object to press the reset button, which is located above the antenna on the back of the radio.
Bluetooth contact synchronisation not working.	Make sure that the "share contacts" option is confirmed within the settings menu specific to the Bluetooth connection between the mobile device and the DAB adapter.
Mobile device will not connect via Bluetooth.	Enter Bluetooth settings on the mobile device and "forget" the connection to the NBDAB350BT, now perform a system reset on the NBDAB350BT and try connecting once the DAB adapter has restarted.
Downloading files from <a href="http://www.nextbase.co.uk">www.nextbase.co.uk</a> using Google Chrome results in a Malicious Software message.	This is not a cause for concern, simply go to the settings within Google Chrome and turn off the malicious software protection temporarily to download and install the playback software. Reinststate previous Google Chrome settings thereafter.
Unresolved issues.	Reset the DAB adapter to the Default Settings within the Menu and try again. Should the problem persist call the helpline (02920) 866429 or email: <a href="mailto:support@nextbase.co.uk">support@nextbase.co.uk</a>

NOTES

# ***NEXT BASE***

[www.nextbase.co.uk](http://www.nextbase.co.uk)



NBDAB350BT-IM-ENG-R6